

80 Series Thermostat with Automatic Heat/Cool Changeover Option

Single Stage, Multi-Stage or Heat Pump Installation and Operating Instructions for Model:

Save these instructions for future use!

FAILURE TO READ AND FOLLOW ALL INSTRUCTIONS CAREFULLY BEFORE INSTALLING OR OPERATING THIS CONTROL COULD CAUSE PERSONAL INJURY AND/OR PROPERTY DAMAGE.

Model	Programming Choices		
1F85CA-0471	5/1/1 Day	5/2 Day	Non-Programmable
1F85-0471	5/1/1 Day	5/2 Day	Non-Programmable
1F83-0471	Non-Programmable		

APPLICATIONS

THERMOSTAT APPLICATION GUIDE

Description	
Heat Pump (No Aux. or Emergency Heat)	Yes
Heat Pump (with Aux. or Emergency Heat)	Yes
Systems with up to 2 Stages Heat, 2 Stages Cool	Yes
Heat Only Systems (with optional fan switch)	Yes
Millivolt Heat Only Systems – Floor or Wall Furnaces	Yes
Cool Only Systems	Yes
Gas or Oil Heat	Yes
Electric Furnace	Yes
Hydronic (Hot Water) Zone Heat – 2 Wires	Yes
Hydronic (Hot Water) Zone Heat – 3 Wires	Yes
Compressor with Comfort Alert II Module (1F85CA only)	Yes

1F85CA-0471 Thermostat



SPECIFICATIONS

Electrical Rating:

Battery Power	mV to 30 VAC, NEC Class II, 50/60 Hz or DC
Input-Hardwire	20 to 30 VAC
Terminal Load	1.5 A per terminal, 2.5A maximum all terminals combined
Setpoint Range	45° to 90°F (7° to 32°C)
Differential (Single Stage)	Heat 0.6°F; Cool 1.2°F (adjustable)
Differential (Heat Pump)	Heat 1.2°F; Cool 1.2°F (adjustable)
Operating Ambient	32° to +105°F (0° to +41°C)
Operating Humidity	90% non-condensing max.
Shipping Temperature Range	-40° to +150°F (-20° to +65°C)
Dimensions Thermostat	4.0"H x 5.11"W x 1.3"D

CAUTION

To prevent electrical shock and/or equipment damage, disconnect electric power to system at main fuse or circuit breaker box until installation is complete.

Index	Page
Installation	2
Wiring Connections	2
Wiring Diagrams	3
Thermostat Quick Reference	4
Installer Configuration Menu	5
Operating Your Thermostat	7
Programming	7
Troubleshooting	9

ATTENTION: MERCURY NOTICE

This product does not contain mercury. However, this product may replace a product that contains mercury.

Mercury and products containing mercury must not be discarded in household trash. Do not touch any spilled mercury. Wearing non-absorbent gloves, clean up any spilled mercury and place in a sealed container. For proper disposal of a product containing mercury or a sealed container. Refer to www.white-roddgers.com for location to send product containing mercury.

INSTALLATION

WARNING

Thermostat installation and all components of the control system shall conform to Class II circuits per the NEC code.

Remove Old Thermostat

A standard heat/cool thermostat consists of three basic parts:

1. The cover, which may be either a snap-on or hinge type.
2. The base, which is removed by loosening all captive screws.
3. The switching subbase, which is removed by unscrewing the mounting screws that hold it on the wall or adapter plate. **Before removing wires from old thermostat, label each wire with the terminal designation from which it was attached.** Disconnect the wires from the old thermostat one at a time. **Do not let wires fall back into the wall.**

Installing New Thermostat

1. Pull the thermostat body off the thermostat base. Forcing or prying on the thermostat will cause damage to the unit.
2. Place base over hole in wall and mark mounting hole locations on wall using base as a template.
3. Move base out of the way. Drill mounting holes. If you are using existing mounting holes and the holes drilled are too large and do not allow you to tighten base snugly, use plastic screw anchors to secure the base.
4. Fasten base snugly to wall using mounting holes shown in Figure 2 and two mounting screws. Leveling is for appearance only and will not affect thermostat operation.
5. Connect wires to terminal block on base.
6. Push excess wire into wall and plug hole with a fire resistant material (such as fiberglass insulation) to prevent drafts from affecting thermostat operation.
7. Carefully line the thermostat up with the base and snap into place.

Batteries

2 “AA” alkaline batteries are included with the thermostat. To install the batteries, pull the battery door as shown by the arrow and lift open. Using the polarity indicated inside the battery door, insert the batteries. To close the battery door, swing the door down while pulling in the direction of arrow. Once fully down, snap the door back into position. To replace the batteries, set system to OFF.

Figure 1 – Battery door shown open

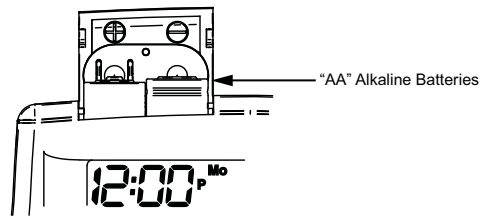

Thermostat can be powered by system AC power or Battery. If is displayed, the thermostat is battery powered. If is not displayed, thermostat is system powered with optional battery back-up. When battery power remaining is approximately half, the will be displayed. When “Change ” is displayed, install fresh “AA” alkaline batteries immediately. For best results, replace all batteries with new premium brand alkaline batteries such as Duracell® or Energizer®. We recommend replacing batteries every 2 years. If the home is going to be unoccupied for an extended period (over 3 months) and is displayed, the batteries should be replaced before leaving. When less than two months of battery life remain, the setpoint temperature will offset by 10 degrees (10 degrees cooler in Heat mode / 10 degrees warmer in Cool mode). If offset occurs, the normal setpoint can be manually reset with or . Another offset will occur within two days if batteries are not replaced.

Figure 2 – Thermostat base and rear view of thermostat

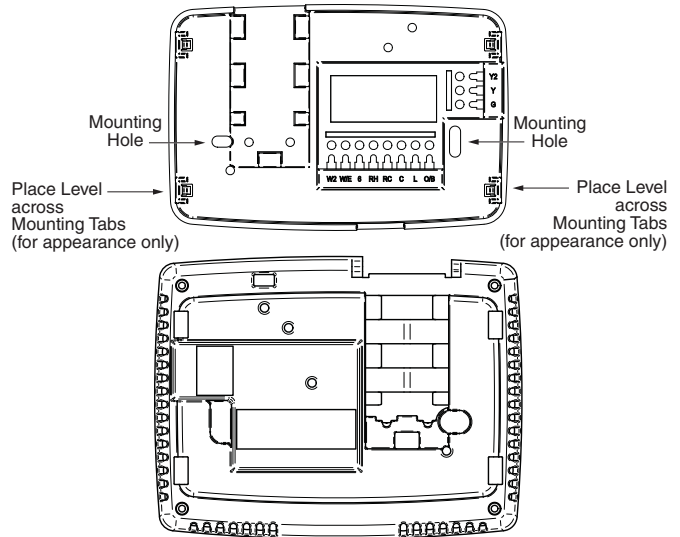

WIRING CONNECTIONS

Refer to equipment manufacturers’ instructions for specific system wiring information. After wiring, see CONFIGURATION section for proper thermostat configuration.

Refer to figure 3 through 6 for wiring diagram specifications.

TERMINAL DESIGNATION DESCRIPTIONS

Terminal Designation	Description	Terminal Designation	Description
L.....	Heat pump malfunction indicator for systems with malfunction connection or Comfort Alert signal	W/E.....	Heat Relay/Emergency Heat Relay (Stage 1)
O.....	Changeover valve for heat pump energized constantly in cooling	W2.....	2nd Stage Heat (3rd Stage Heat in HP 2)
B.....	Changeover valve for heat pump energized constantly in heating	G.....	Fan Relay
Y.....	Compressor Relay	RH.....	Power for Heating
Y2.....	2nd Stage Compressor	RC.....	Power for Cooling
		C.....	Common wire from secondary side of cooling system transformer or heat only system transformer
		6.....	3 Wire Zone Valve – Energized when no call for Heat

WIRING DIAGRAMS

Heat Pump Connections

If you do not have a heat pump system, refer to figures 4-6. Refer to equipment manufacturers' instructions for specific system wiring information. You can configure the thermostat for use with the following heat pump systems.

HEAT PUMPTYPE 1 (HP 1). Single stage compressor system; gas or electric backup.

HEAT PUMPTYPE 2 (HP 2). Multi-stage compressor or two compressor system with gas or electric backup. After wiring, see INSTALLER CONFIGURATION section for proper thermostat configuration.

Figure 3 – Heat Pump Systems

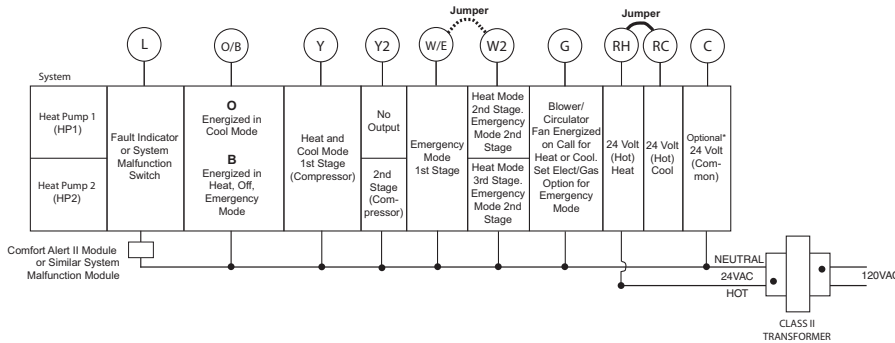

NOTE: If your system does not provide an E connection, jumper W2 to W/E to use the Auxiliary Heat in the Emergency Mode.

* Common connection required for fault or malfunction indication.

Single Stage and Multi-Stage Connections

Refer to equipment manufacturers' instructions for specific system wiring information. This thermostat is designed to operate a single-transformer or two-transformer system. You can configure the thermostat for use with the following fossil fuel systems:

SINGLE STAGE (SS 1) gas, oil or electric.

MULTI-STAGE (MS 2) gas, oil or electric.

After wiring, see INSTALLER CONFIGURATION section for proper thermostat configuration.

Figure 4 – Single Stage or Multi-Stage System (No Heat Pump) with Single Transformer

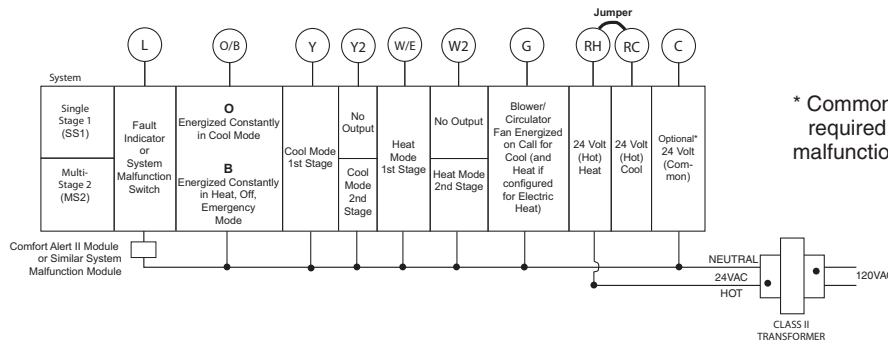

* Common connection required for fault or malfunction indication.

Figure 5 – Single Stage or Multi-Stage System (No Heat Pump) with Two Transformers

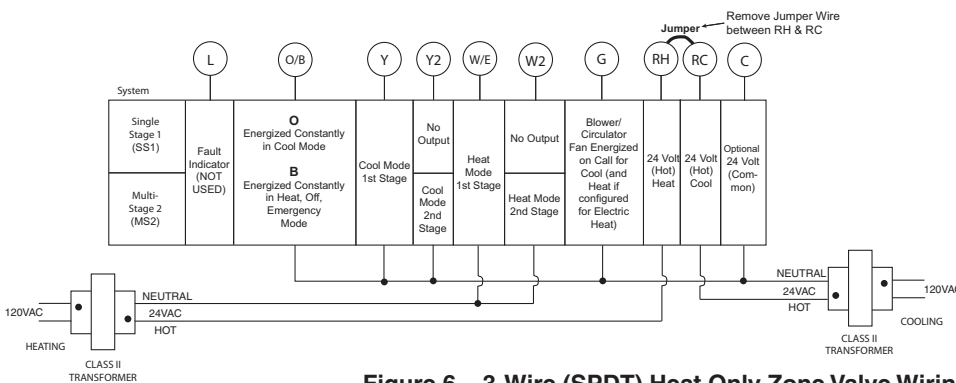

NOTE: If continuous backlight or hardwired power input are desired but do not function in both HEAT and COOL modes, cut the heating transformer 24VAC wires and tape off. Connect the neutral circuit disconnected from the heating transformer to the neutral circuit of the cooling transformer. Disconnect the wire to the RH terminal and install a jumper between RH and RC. Depending on the system requirements, replace the cooling transformer with a 75VA class II transformer if needed.

Figure 6 – 3-Wire (SPDT) Heat Only Zone Valve Wiring

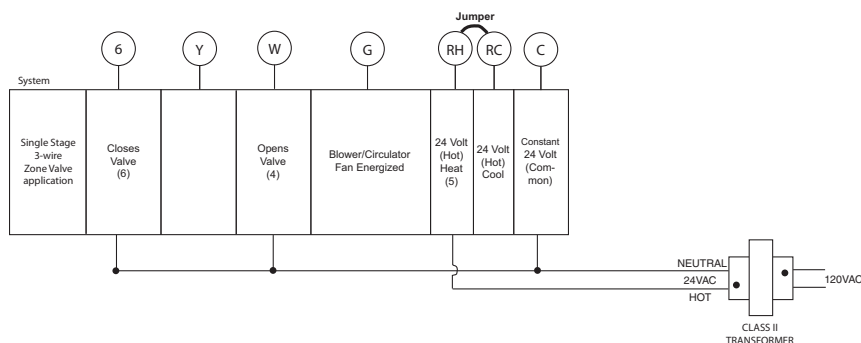

THERMOSTAT QUICK REFERENCE

Home Screen Description

Figure 7 – Home Screen Display

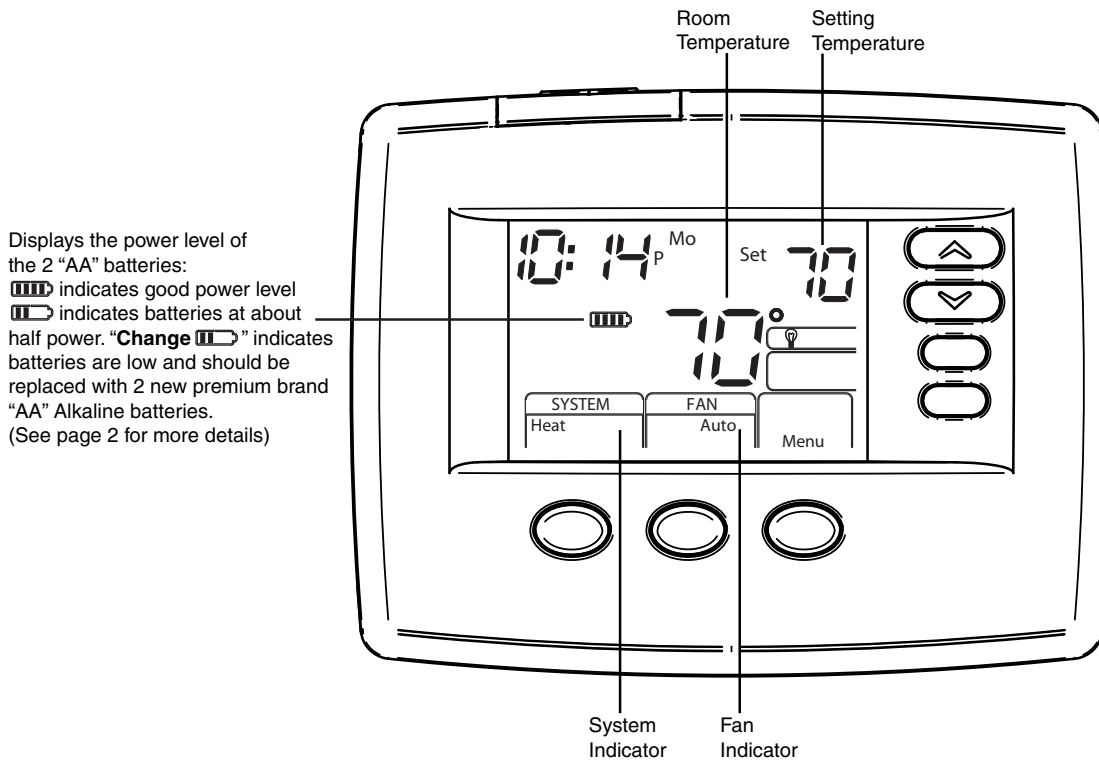

Displays the power level of the 2 "AA" batteries:
 ■■■■ indicates good power level
 ■■■ indicates batteries at about half power. "Change ■■■" indicates batteries are low and should be replaced with 2 new premium brand "AA" Alkaline batteries.
 (See page 2 for more details)

Programming and Configuration Items



- ① "System On" indicates when heating or cooling stage is energized. "System On +2" indicates when a second stage is energized.
- ② The word "Hold" is displayed when the thermostat is in the Hold mode. "Temp Hold" is displayed when the thermostat is in a Temporary Hold mode.
- ③ Displays "Change Filter" when the system has run for the programmed filter time period as a reminder to change or clean your filter.
- ④ Displays "Set" for setpoint when in Run Program mode.
- ⑤ Displays System Mode (Heat, Emer, Auto, Cool, Off) or "Time" in Menu Mode.
- ⑥ Displays Fan Mode (On, Auto) or "Run Sched" in Menu Mode.
- ⑦ Displays "Run Schedule", "Schedule", or "Menu".
- ⑧ Displays "Save" when Cool Savings™ is working.
- ⑨ Displays "Heat Pump" when system is configured as Heat Pump thermostat.
- ⑩ Displays "Hold" in programmable mode. When not in Hold mode, displays ⚡ (light bulb) in non-programmable mode.

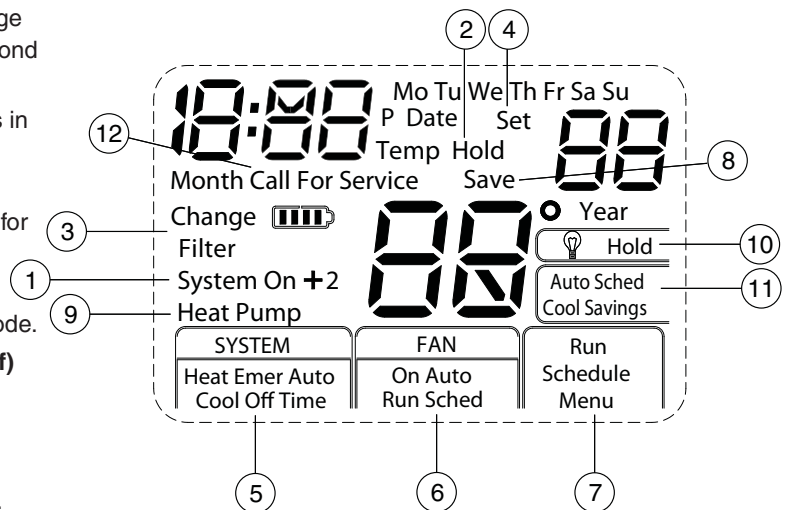

Figure 8 – Programming & Configuration Items





- ⑪ Initially displays "Auto Sched". If Auto Schedule had been used or disabled, then it displays "Cool Savings" when in the Cool Mode if Cool Savings has been enabled in the menu.
- ⑫ "Call For Service" indicates a fault in the heating/cooling system, it does not indicate a fault in the thermostat.





INSTALLER/CONFIGURATION MENU

Press the Menu button for at least 5 seconds. The display will show item #1 in the table below. Press Menu button to advance to the next menu item. Press  or  to change a menu item. Shaded items not available on 1F83 model.



INSTALLER/CONFIGURATION MENU						
MENU REF.	HP	SS	PRESS BUTTON	DISPLAYED (FACTORY DEFAULT)	Press  or  to select from listed options	COMMENTS
1	1	1	MENU	(MS 2)	HP 1, HP 2, SS 1	Selects Multi-Stage (MS 2 No Heat Pump), Heat Pump 1 (HP 1, 1 compressor), or Single Stage (SS 1), Heat Pump 2 (HP 2, 2 compressor or 2 speed compressor)
2	2	2	MENU	(GAS) for SS or MS (ELE) for HP	ELE	GAS setting: furnace controls the blower ELE setting: thermostat controls the blower
3	3	3	MENU	CS (0) (Disabled)	1, 2, 3, 4, 5, 6	Selects Cool Savings Value 1 (low) to 6 (high), Value 0 Disables Feature
4	4	4	MENU	E (On)	OFF	Selects Energy Management Recovery (EMR) On or OFF. NA 1F83.
5	–	5	MENU	CR Heat (ME)	SL, FA	Adjustable Anticipation: Selects heating cycle rate for MS or SS
6	5	–	MENU	CR Heat Pump (ME)	SL, FA	Adjustable Anticipation (Heat Pump) (only when heat pump selected in #1)
7	6	6	MENU	CR Cool (ME) or CR Emer (FA)	SL, FA SL	Adjustable Anticipation: Selects the cycle rate for cooling (only when MS 2 or SS 1 is selected in item 1.) or Selects the cycle rate for Emergency mode and Auxiliary stage if Heat Pump is selected in item 1.
8	7	7	MENU	CL (OFF)	CL On	Compressor Lockout Time
9	8	8	MENU	Heat Auto Cool Off	Heat Cool Off, Heat Off with Fan icon, Heat Off without Fan icon Cool Off, Auto Off	System Mode Configuration with Automatic Changeover capability
10	9	9	MENU	dL (On)	dL OFF	Selects Display Light On or OFF
11	10	10	MENU	0 (current temperature)	1 HI, 2 HI, 3 HI, 4 HI, 1 LO, 2 LO, 3 LO, 4 LO	Adjustable Ambient Temperature Display
12	11	11	MENU	°F	°C	Selects Fahrenheit/Celsius Temperature Display
13	12	12	MENU	L Heat (90)	L 62 to L 89	Selects Limited HEAT Range
14	13	13	MENU	L Cool (45)	L 46 to L 82	Selects Limited COOL Range
15	14	14	MENU	P3	P0, P2	Defaults for 5-1-1 programming (P3) but non-programmable (P0) or 5-2 programming (P2) is available on most models. NA 1F83.
16	15	15	MENU	Heat AS (On)	OFF	Automatic Schedule for heat mode. NA 1F83. NA to Cool only system.
17	16	16	MENU	Cool AS (On)	OFF	Automatic Schedule for cool mode. NA 1F83. NA to Heat only system.
18	17	–	MENU	Heat FA (On)	OFF	Fast Heat option may be disabled by selecting OFF. NA to SS config. NA to Cool only system.
19	18	–	MENU	Cool FA (On)	OFF	Fast Cool option may be disabled by selecting OFF. NA to SS config. NA to Heat only system.
20	19	17	MENU	CA (OFF)	On	Selects active Comfort Alert On or OFF. Requires CA II Module. (1F85CA only)
21	20	18	MENU	dS (On)	OFF	Selects Automatic daylight Savings Time option On or OFF. NA 1F83.
22	21	19	MENU	Change Filter (OFF)	On	Selects Filter Change-out Indicator On or OFF.
			MENU	Change Filter (200 h)	25-1975 h	Change Filter time in 25 hour increments. This menu only appears if On is selected in above.
23	22	20	MENU	Cool On (o)	Heat On (b)	Selects operation of the reversing valve terminal (O/B) output as an O or B terminal.
24	23	21	RUN SCHED			Returns to Normal Operation

INSTALLER/CONFIGURATION MENU

- 1) This control can be configured for:
 MS 2 – Multi-Stage System (no heat pump)
 HP 1 – Heat Pump with one stage of compressor
 HP 2 – Heat Pump with two stage compressor or two compressor system, Gas or Electric backup
 SS 1 – Single Stage System
- 2) GAS or Electric (ELE) fan operation. If the heating system requires the thermostat to energize the fan, select ELE. Select GAS if the heating system energizes the fan on a call for heat.
- 3) **Select Cool Savings™ value** – Selects the amount of adjustment for the Cool Savings™ feature in Cool mode with 1 (1°) being the least amount of adjustment and 6 (6°) being the most amount of adjustment. Default value is 0 which disables this feature. Selecting a value greater than 0 will display Cool Savings on the screen and enable the key for Cool Savings feature. Cool Savings is an optional energy saving feature that can reduce your cooling costs. It is based on the principal that lower indoor humidity makes a slightly higher temperature feel more comfortable. Cool Savings operates during periods of high demand which normally occur on the hottest summer days when a cooling system may run for hours to reach the thermostat setting. Long cooling run times also lower the indoor humidity. Cool Savings, very slowly, adjusts the setpoint temperature to make the setpoint closer to the displayed room temperature, to a maximum of the number of degrees you select. Adjusting the setpoint temperature over a long cooling run time allows the system to reach your set temperature and turn off. The room temperature will actually be higher than the thermostat displays but the reduction in humidity will allow comfort at the slightly higher temperature. To turn this feature on in the Cool mode press **Cool Savings**. The display will show “Save” next to the setpoint temperature. When Cool Savings is making adjustments to the room temperature display “Save” will be flashing and the displayed room temperature may vary within the adjustment range you selected. If “Save” is not displayed and this feature is OFF, no change will occur when the cooling system is continuously running during periods of high demand.
- 4) **Energy Management Recovery:** (this step is skipped if configured to be non-programmable). Energy Management Recovery (E) On enables the thermostat to start heating or cooling early to make the building temperature reach the program setpoint at the time you specify. Heating will start 5 minutes early for every 1° of temperature required to reach setpoint.
Example: E On is selected and your heating is programmed to 65° at night and 70° at 7 AM. If the building temperature is 65°, the difference between 65° and 70° is 5°. Allowing 5 minutes per degree, the thermostat setpoint will change to 70° at 6:35 AM. Cooling allows more time per degree, because it takes longer to reach set temperature.
- 5, 6 & 7) **Cycle Rate Selection** – The factory default setting for Heat and Cool modes, SS1, MS2, is medium cycle (ME). For Heat Pump, HP1, HP2, the default setting is medium (ME). For Emer (Aux) the default setting is fast cycle (FA). To change cycle rate, press the  or  key.
 Cycle rate differentials for different settings are:

MODE	Fast	Medium	Slow
	FA	ME	SL
Heat (SS1, MS2)	0.4°F	0.6°F	1.7°F
Cool (SS1, MS2)	0.9°F	1.2°F	1.7°F
Heat Pump (HP1, HP2)	0.9°F	1.2°F	1.7°F
Emer (HP1, HP2)	0.6°F	-	1.7°F
- 8) **Select Compressor Lockout CL OFF or ON** – Selecting CL ON will cause the thermostat to wait 5 minutes between cooling cycles. This is intended to help protect the compressor from short cycling. Some newer compressors already have a time delay built in and do not require this feature. Your compressor manufacturer can tell you if the lockout feature is already present in their system. When the thermostat compressor time delay occurs, it will flash the setpoint for up to five minutes.
- 9) **System Mode Configuration** – This thermostat is configured for Heat and Cool (SYSTEM switch with Cool, Off, Heat) default. It can also be configured for Heat and Cool with Auto changeover (Heat, Auto, Cool, Off), Heat only with fan (Off, Heat), Heat only without fan, Auto only (Auto, Off), and Cool only (Cool, Off).
- 10) **Select Backlight Display** – The display backlight improves display contrast in low lighting conditions. When the “C” terminal is powered, selecting backlight CdL ON will keep the light on continuously. Select backlight OFF will turn the light on momentarily after any key is pressed. When the “C” terminal is not powered, the light will be on momentarily after any key is pressed no matter whether the backlight is selected ON or OFF.
- 11) **Select Temperature Display Adjustment 4 LO to 4 HI** – Allows you to adjust the room temperature display up to 4° higher or lower. Your thermostat was accurately calibrated at the factory, but you have the option to change the display temperature to match your previous thermostat. The current or adjusted room temperature will be displayed.
- 12) **Select F° or C° Readout** – Changes the display readout to Celsius or Fahrenheit as required.
- 13 & 14) **Temperature Limit Range Heat or Cool** – This selection sets the maximum HEAT (13) or minimum COOL (14) temperature for the setpoint range. Select the limit temperature using the  or  keys. In the **Run Schedule** mode, the setpoint temperature will not adjust past the limit temperature selected. When the limit temperature is reached, trying to raise or lower the setpoint past the limit will cause “L” to be displayed in the times digits for about 6 seconds. This feature not available on earlier models.
- 15) **Program Options:** Not available on 1F83, configured for 5/1/1 day or 5/2 day programming or non-programmable mode. The default setting is P2, indicating 5/2 day programming. The programs per week can be toggled to P3 or P0 by pressing the  or  keys. A selection of 0 Days for non-programmable will eliminate the need for EMR, and that step in the menu will be skipped.
- 16 & 17) **Select Automatic Schedule** – Not available on 1F83, with just one touch of the **Auto Schedule** button this feature allows you to program a desired comfort temperature into all the program periods along with a 6° set back for night periods of both Heat and Cool programs. Factory default is “On” for both. When **Heat AS On** and **Cool AS On** are activated while in Heat or Cool mode, select desired setpoint temperature and press **Auto Schedule**. This value will be copied into all the morning, day and evening program periods. The night program periods will have a 6°F set back.
- 18 & 19) **Select Fast Second Stage ON or OFF** – Heat pump or Multi-stage only, in the run mode, with the fast Heat feature enabled (FA Heat On), if the Heat setpoint temperature is manually raised by 3°F (2°C) or more above the actual temperature using , the second stage will energize immediately. With FA OFF, second stage will not energize until the setpoint temperature is 1°F or more above actual temperature for more than ten minutes. The Fast Cool feature (FA Cool) provides the same controls when the setpoint temperature is lowered.

INSTALLER/CONFIGURATION MENU

- 20) **Comfort Alert with Active Protection** – Turn this feature ON to enable active protection. This allows the thermostat to identify fault codes sent by the Comfort Alert module when compressor damage is possible and react to those codes by turning the compressor off. Fault codes from the Comfort Alert module will flash on the thermostat. (Refer to Comfort Alert Yellow Alert Codes in Troubleshooting section.) If a Comfort Alert module is not connected, or to disable active protection, turn this feature OFF. If a Comfort Alert module is connected and this feature is turned OFF, the thermostat will still receive and flash the fault codes from the Comfort Alert module, but the active protection will not be enabled to protect the compressor.
- 21) **Select Daylight Saving Time Calculation** – Not available on 1F83, this feature will allow the thermostat to calculate the DST automatically and apply it to the Real Time Clock display. Default On. Use  or  buttons to select the feature OFF.
- 22) **Select Filter Replacement Reminder and Set Run Time** – Select the “**Change Filter**” reminder On or OFF. If selected On, press **MENU** to select the time period from 25 to 1975 hours in 25 hours increments. In a typical system, 200 hours (default) of run time is approximately 30 days. After the selected time of blower operation, the thermostat will display “**Change Filter**” as a reminder to change or clean your air filter. When “**Change Filter**” is displayed, press **MENU** or **RUN SCHED** button to clear the display and restart the time to the next filter change.
- 23) **Select Reversing Valve Output** – The O/B option is factory set at “O” position. This will accommodate the majority of heat pump applications, which require the changeover relay to be energized in COOL. If the thermostat you are replacing or the heat pump being installed with this thermostat requires a “B” terminal, to energize the changeover relay in HEAT, the O/B option should be set at “B” position.

OPERATING YOUR THERMOSTAT

Choose the Fan Setting (Auto or On)

Press the FAN button to **Auto** or **On**.

Fan Auto is the most commonly selected setting and runs the fan only when the heating or cooling system is on.

Fan On runs the fan continuously for increased air circulation or to allow additional air cleaning.

Choose the System Setting (Heat, Off, Cool, Auto, Emer)

Press the SYSTEM button to select:

Heat: Thermostat controls only the heating system.

Off: Heating and Cooling systems are off.



Cool: Thermostat controls only the cooling system.

Auto: Auto Changeover is used in areas where both heating and cooling may be required on the same day. **AUTO** allows the thermostat to automatically select heating or cooling depending on the indoor temperature and the selected heat and cool temperatures. When using **AUTO**, be sure to set the Cooling temperatures more than 1° Fahrenheit higher than the heating temperature.



Emer: (Heat Pump models) Thermostat controls only backup heating system.

IMPORTANT!





Manual Operation for Non-Programmable Mode

Press the SYSTEM button to select Heat or Cool and use the  or  buttons to adjust the temperature to your desired setting. After selecting your desired settings you can also press the SYSTEM button to select **AUTO** to allow the thermostat to automatically change between Heat and Cool.

Manual Operation (Bypassing the Program) Programmable Thermostats







Press  or  and then the HOLD button and adjust the temperature wherever you like. This will override the program. The **HOLD** feature bypasses the program and allows you to adjust the temperature manually, as needed. Whatever temperature you set in **HOLD** will be maintained 24 hours a day, until you manually change the temperature or press **Run Sched** to cancel **HOLD** and resume the programmed schedule.

Program Override (Temporary Override)

Press  or  buttons to adjust the temperature. This will override the temperature setting for two hours minimum or until the next programmed time. To cancel the temporary setting at any time and return to the program, press **Run Sched**. If the SYSTEM button is pressed to select **AUTO** the thermostat will change to Heat or Cool, whichever ran last. If it switches to heat but you want cool, or it changes to cool but you want heat, press both  and  buttons simultaneously to change to the other mode.





PROGRAMMING (For Programmable Model Only)

Set Current Time and Date

- 1) Press Menu and then Time button once. The display will show the hour only.
- 2) Press and hold either the  or  button until you reach the correct hour and AM/PM designation (AM begins at midnight, PM begins at noon).
- 3) Press Time once again. The display window will show the minutes only.
- 4) Press and hold either the  or  button until you reach the correct minutes.
- 5) Additional presses of Time will advance the display to show the year, month and date of month. Press the  or  button to change the display to the correct setting for each.
- 6) Press Run Sched to exit the Time mode.

PROGRAMMING (For Programmable Model Only)

Enter the Heating Program

- 1) Press SYSTEM button to select “Heat” in the system switch area indicating the active mode being programmed.
- 2) Press the Menu button and then press Schedule.
- 3) The top of the display will show the day(s) being programmed. The time and temperature (flashing) are also displayed. “1” will also be displayed to indicate the period.
- 4) Press  or  button to change the temperature to your selected temperature for the 1st heating period.
- 5) Press Time button, time will flash.
- 6) Press  or  button to adjust the start time for the 1st period.
- 7) The time will change in 15 minute increments.
- 8) After you have set the time and the temperature for the period to begin, press Schedule to advance to the next program period.

- 9) Repeat steps 2 through 8 until all of the program times and temperatures are set for all program periods on that day.
- 10) Press Schedule to the next day and repeat steps 2 through 9.
- 11) When programming is complete and all of the times and temperatures match your desired heating schedule, press Run Schedule. The thermostat will now run your program.

Enter the Cooling Program

- 1) Press SYSTEM button to select “Cool” in the system switch area indicating the active mode being programmed.
- 2) Follow **Enter Heating Program** instructions for entering cooling times and temperatures.

Energy Saving ENERGY STAR® Factory Pre-Program

The programmable thermostats are programmed with the energy saving settings shown in the table below for all days of the week. If this program suits your needs, simply set the

thermostat clock and press the RUN Sched button. The table below shows the factory set heating and cooling schedule for all days of the week.

	Wake Up (Period 1)		Leave For Work (Period 2)		Return Home (Period 3)		Go To Bed (Period 4)	
Heating Program	6:00 AM	70°F	8:00 AM	62°F	5:00 PM	70°F	10:00 PM	62°F
Cooling Program	6:00 AM	75°F	8:00 AM	83°F	5:00 PM	75°F	10:00 PM	78°F

Planning Your Program – Important

The Heating and Cooling Program schedules below allow you to pencil in your own program times and temperatures. The programmable comes configured for 5/1/1 day programming and can also be configured for 5/2 day programming (see configuration section).

Factory settings are listed on Monday through Friday, Saturday and Sunday. If you are re-programming a 5/2 day schedule, pencil in your own times and temperatures directly below the factory times and temperatures.

If you are re-programming a 5+1+1 fill in all lines with the times and temperatures you want.

Keep the following guidelines in mind when planning your program.

- In Heating, lower temperatures will save energy.
- In Cooling, higher temperatures will save energy.
- **If you plan on using Auto Changeover, do not program the heating higher than the cooling.**

Worksheet for Re-Programming 5/2 Day and 5+1+1 Day Program

Heating Program	Wake Up (Period 1)		Leave For Work (Period 2)		Return Home (Period 3)		Go To Bed (Period 4)	
Mo-Fri	6:00 AM	70°F	8:00 AM	62°F	5:00 PM	70°F	10:00 PM	62°F
Sat-Sun or Sat	6:00 AM	70°F	8:00 AM	62°F	5:00 PM	70°F	10:00 PM	62°F
Sun 5+1+1 only	6:00 AM	70°F	8:00 AM	62°F	5:00 PM	70°F	10:00 PM	62°F

Cooling Program	Wake Up (Period 1)		Leave For Work (Period 2)		Return Home (Period 3)		Go To Bed (Period 4)	
Mo-Fri	6:00 AM	75°F	8:00 AM	83°F	5:00 PM	75°F	10:00 PM	78°F
Sat-Sun or Sat	6:00 AM	75°F	8:00 AM	83°F	5:00 PM	75°F	10:00 PM	78°F
Sun 5+1+1 only	6:00 AM	75°F	8:00 AM	83°F	5:00 PM	75°F	10:00 PM	78°F



TROUBLESHOOTING

Reset Operation

Note: When thermostat is reset, installer configuration menu settings and programming will reset to factory settings. If a voltage spike or static discharge blanks out the display or causes erratic thermostat operation, you can reset the thermostat by removing the wires from terminals **R** and **C** (do not short them together) and removing batteries for 2 minutes. After resetting the thermostat, replace the wires and batteries. If the thermostat has been reset and still does not

function correctly contact your heating/cooling service person or place of purchase.

Note: Be sure to review the installer configuration menu settings.

To reset the programming, clock and configuration settings, press  and  and the FAN button simultaneously. The thermostat should go blank and then all segments will be displayed momentarily.

Symptom	Possible Cause	Correction Action
No Heat/No Cool/No Fan (common problems)	<ol style="list-style-type: none"> Blown fuse or tripped circuit breaker. Furnace power switch to OFF. Furnace blower compartment door or panel loose or not properly installed. Loose connection to thermostat or system. 	Replace fuse or reset breaker. Turn switch to ON. Replace door panel in proper position to engage safety interlock or door switch. Tighten connections.
No Heat	<ol style="list-style-type: none"> Pilot light not lit. Furnace Lock-Out Condition. Heat may also be intermittent. Heating system requires service or thermostat requires replacement. 	Re-light pilot. Many furnaces have safety devices that shut down when a lock-out condition occurs. If the heat works intermittently contact the furnace manufacturer or local HVAC service person for assistance. Diagnostic: Set SYSTEM Switch to HEAT and raise the setpoint above room temperature. Within a few seconds the thermostat should make a soft click sound. This sound usually indicates the thermostat is operating properly. If the thermostat does not click, try the reset operation listed above. If the thermostat does not click after being reset contact your heating and cooling service person or place of purchase for a replacement. If the thermostat clicks, contact the furnace manufacturer or a HVAC service person to verify the heating is operating correctly.
No Cool	<ol style="list-style-type: none"> Cooling system requires service or thermostat requires replacement. 	Same as diagnostic for No Heat condition except set the thermostat to COOL and lower the setpoint below the room temperature. There may be up to a five minute delay before the thermostat clicks in Cooling.
Heat, Cool or Fan Runs Constantly	<ol style="list-style-type: none"> Possible short in wiring. Possible short in thermostat. Possible short in heat/cool/fan system. FAN Switch set to Fan ON. 	Check each wire connection to verify they are not shorted or touching together. No bare wire should stick out from under terminal block. Try resetting the thermostat as described above. If the condition persists the manufacturer of your system or service person can instruct you on how to test the Heat/Cool system for correct operation. If the system operates correctly, replace the thermostat.
Thermostat Setting & Thermostat Thermometer Disagree	<ol style="list-style-type: none"> Thermostat thermometer setting requires adjustment. 	The thermometer can be adjusted +/- 4 degrees. See Temperature Display Adjustment in the Configuration Menu section.
Furnace (Air Conditioner) Cycles Too Fast or Too Slow (narrow or wide temperature swing)	<ol style="list-style-type: none"> The location of the thermostat and/or the size of the Heating System may be influencing the cycle rate. 	Digital thermostats provide precise control and cycle faster than older mechanical models. The system turns on and off more frequently but runs for a shorter time so there is no increase in energy use. If you would like an increased cycle time, choose SL for slow cycle in the Configuration menu, step 6 (heat), 7 (cool) or 8 (heat pump). If an acceptable cycle rate is not achieved, contact a local HVAC service person for additional suggestions.

TROUBLESHOOTING

Comfort Alert Codes

The Comfort Alert diagnostics product monitors the air conditioning outdoor systems with single phase Copeland Scroll compressors. Abnormal system and electrical conditions are indicated by flashing ALERT codes on the yellow LED on the Comfort Alert module. The flash codes are transmitted to the thermostat by the Comfort Alert Thermostat interface module. The Comfort Alert compatible thermostat displays “**Call For Service**” that flashes at the same rate as the yellow LED on the Comfort Alert module.

Comfort Alert Yellow Alert Codes	
1 Flash	Long run time
2 Flashes	System pressure trip
3 Flashes	Short cycling
4 Flashes	Locked rotor
5 Flashes	Open circuit
6 Flashes	Open start circuit
7 Flashes	Open run circuit
8 Flashes	Welded Contactor
9 Flashes	Low voltage

NOTES

HOMEOWNER HELP LINE: 1-800-284-2925

White-Rodgers is a division
of Emerson Electric Co.

The Emerson logo is a
trademark and service mark
of Emerson Electric Co.

White
Rodgers™

www.white-rodgers.com

EMERSON™
Climate Technologies